

**Standard**  
PATENT GLAZING  
ESTABLISHED 1902

# RAFTERLINE

PATENT GLAZING SYSTEM

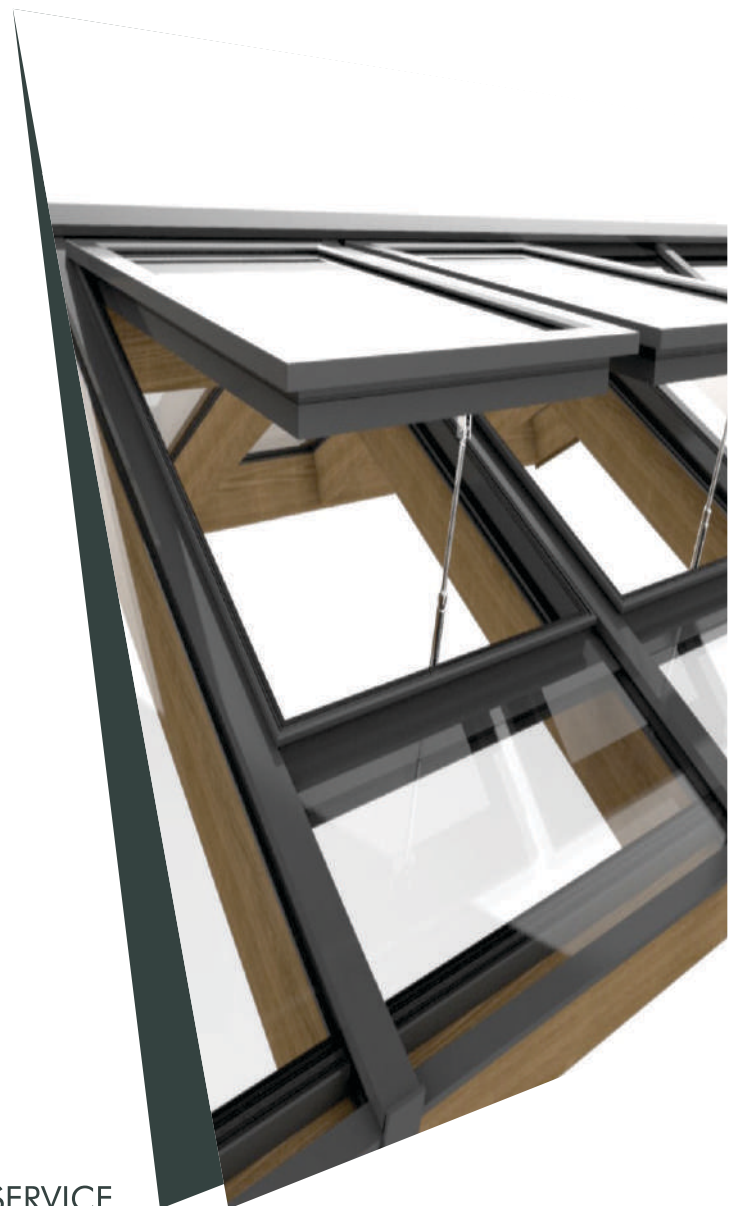
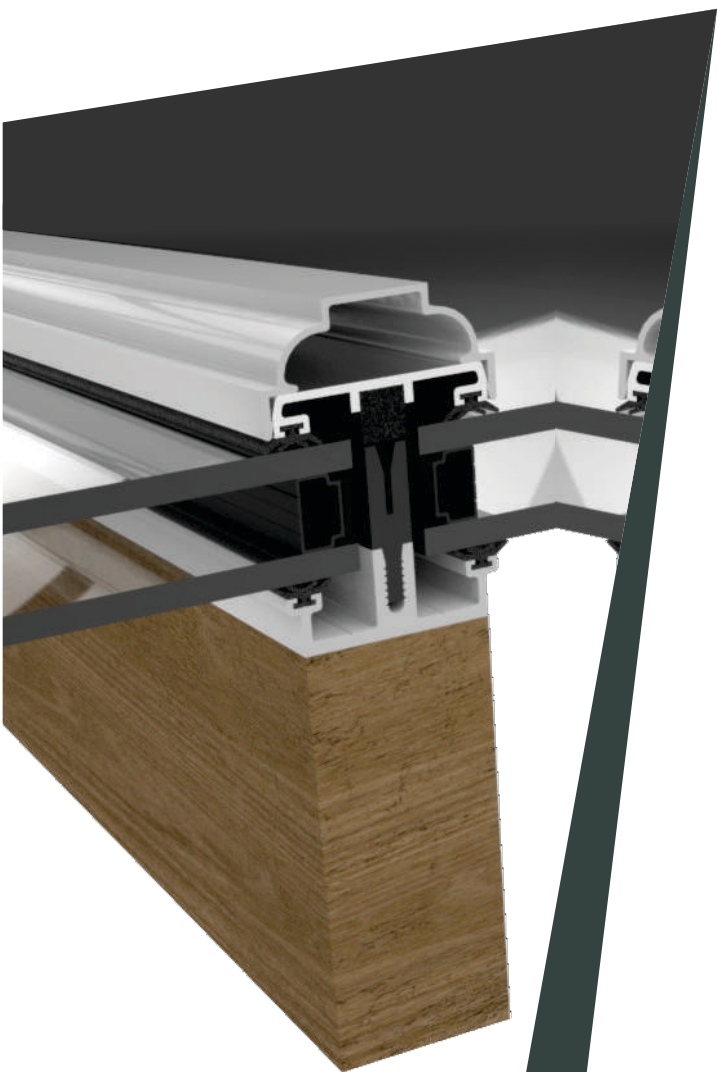

100 YEARS OF SERVICE

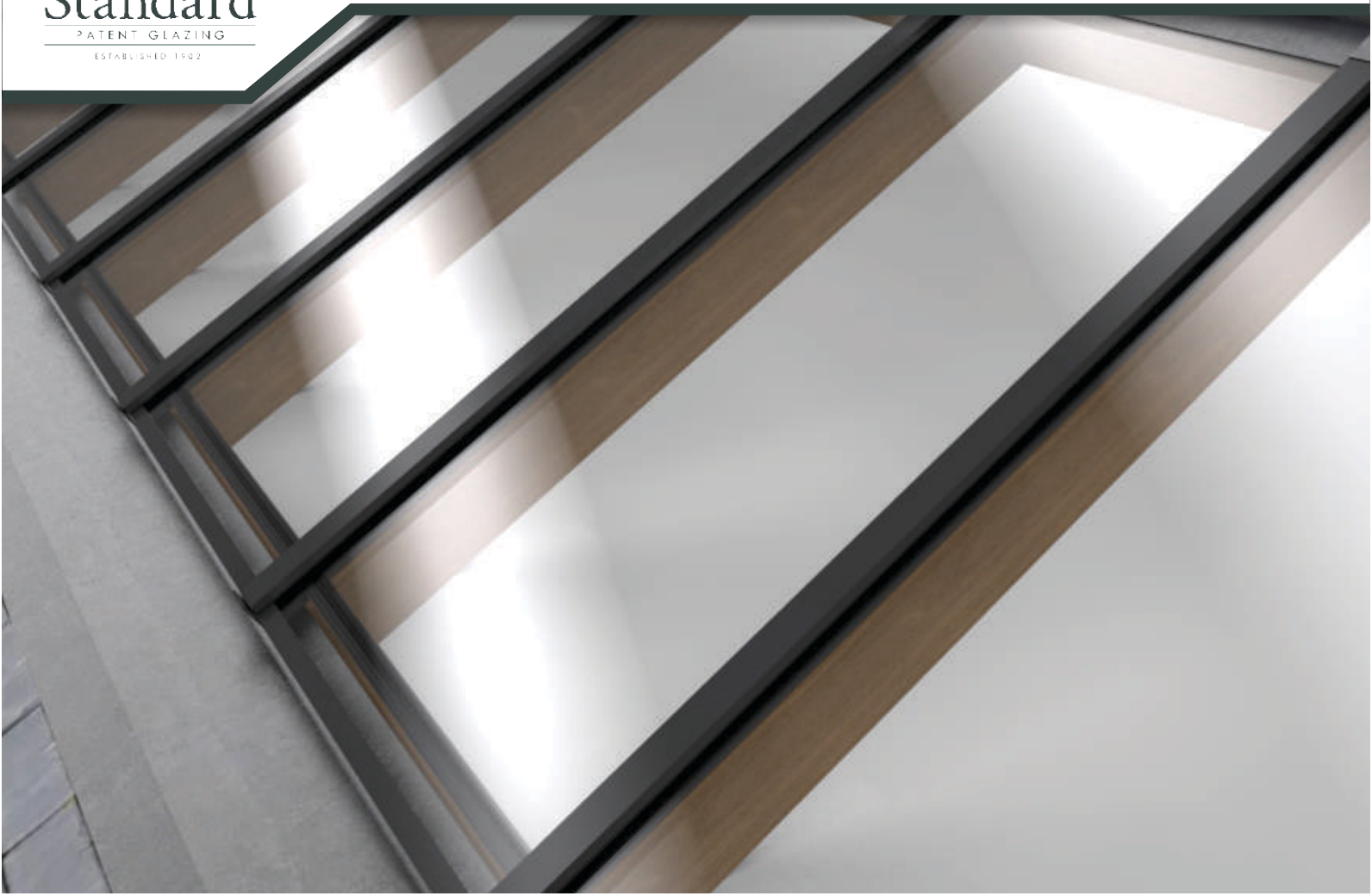

## RAFTERLINE PATENT GLAZING SYSTEM

**The Rafterline glazing bar system is based on the same principles as the popular Skyline SPG range. The internal stalk of the bar in this case is not required.**

The glazing bars' strength is provided by others structural timber rafters x 50mm wide (44mm minimum) and the maximum span of this system is therefore only limited by the integrity of the rafters.

The glazing bar is weathered by a screw on aluminium pressure cap (PC1) with a choice of plain (PC2) or ornate (PC3) cosmetic outer aluminium snap-on cappings to conceal all fixing screws.

The advantages of this system are that the timber rafters create an appealing visual effect inside the building and are totally protected from the effects of weathering from the

elements. The external aluminium glazing system will provide excellent weather resistance and is not subject to the regular maintenance required for timber glazing systems.

Due to the appealing internal appearance of this system, it is regularly requested for domestic use, such as conservatory roofs. The Rafterline glazing system is suitable for double and triple glazed applications where compliance with Building Regulations Document L are a requirement.

This system readily accepts both single glazing, double and triple glazed units up to 50mm thick and as with all our systems, can be combined with opening vents to offer a total glazing solution.

The Rafterline glazing system is our

most popular range of glazing bars on supply only contracts where the thoughtful design of our sections allows for relatively speedy installation by a competent tradesman. The glazing bars can be ordered oversized for on-site cutting if exact sizes are not known at order stage however it is always preferable to order materials at the exact size tailored to your project.

Visit our web site to download AutoCAD or PDF files for all of the Skyline Box range including a wealth of typical interface details with common supporting structure designs.  
[www.patent-glazing.com/downloads.html](http://www.patent-glazing.com/downloads.html)



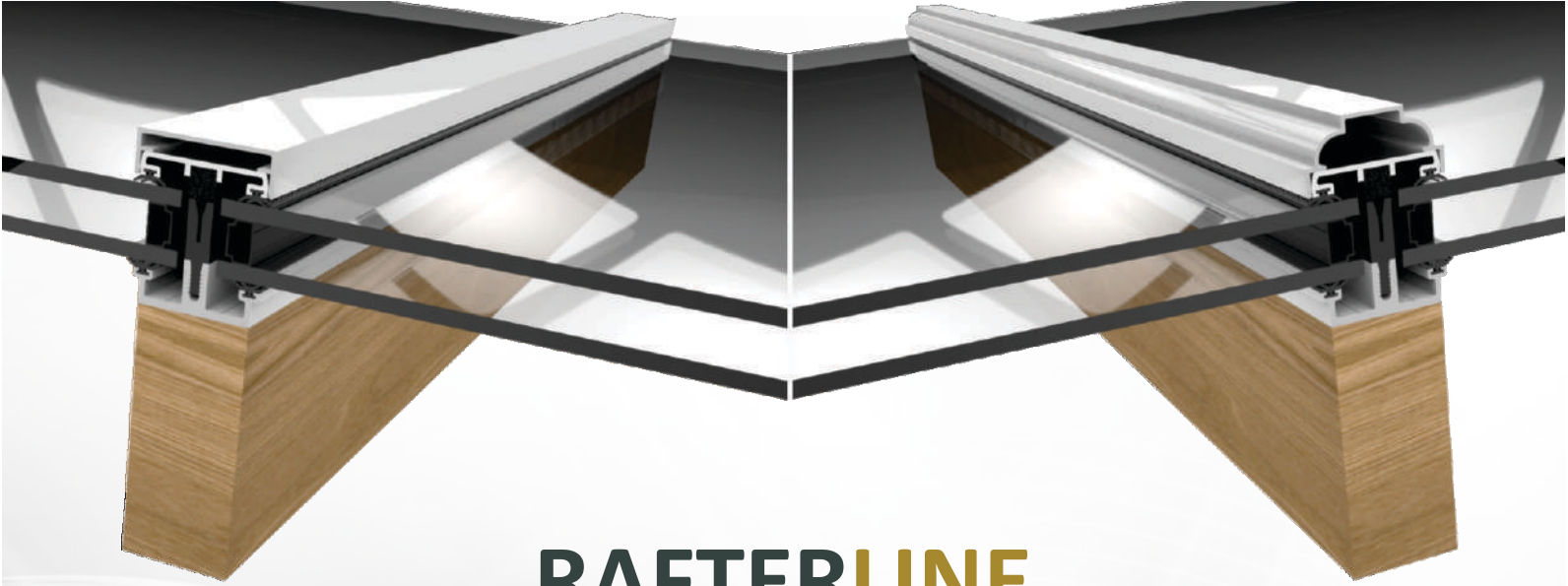

## RAFTERLINE

DOUBLE GLAZED

Rafterline SPG1 type thermally broken extruded aluminium Glazing Bar with screw-on PC1 capping and snap-on cosmetic square topped PC2 capping section - double glazed with 28mm thick double glazed units

Rafterline SPG1 type thermally broken extruded aluminium Glazing Bar with screw-on PC1 capping and snap-on cosmetic ornate topped PC3 capping section - double glazed with 28mm thick double glazed units



## RAFTERLINE

SINGLE GLAZED

Rafterline SPG1 type extruded aluminium Glazing Bar with screw-on PC1 capping and snap-on cosmetic square topped PC2 capping section - single glazed with 6mm thick glass

Rafterline SPG1 type extruded aluminium Glazing Bar with screw-on PC1 capping and snap-on cosmetic ornate topped PC3 capping section - single glazed with 6mm thick glass



# RAFTERLINE

DOUBLE GLAZED

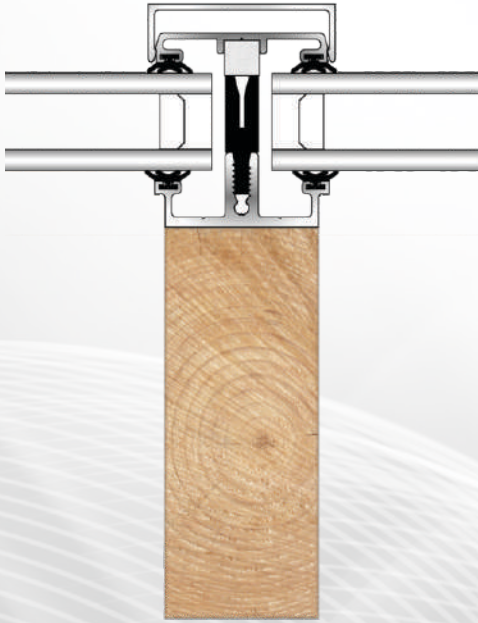

Rafterline SPG1 thermally broken aluminium glazing bar with PC1 screw-on capping and PC2 snap-on square top cosmetic capping

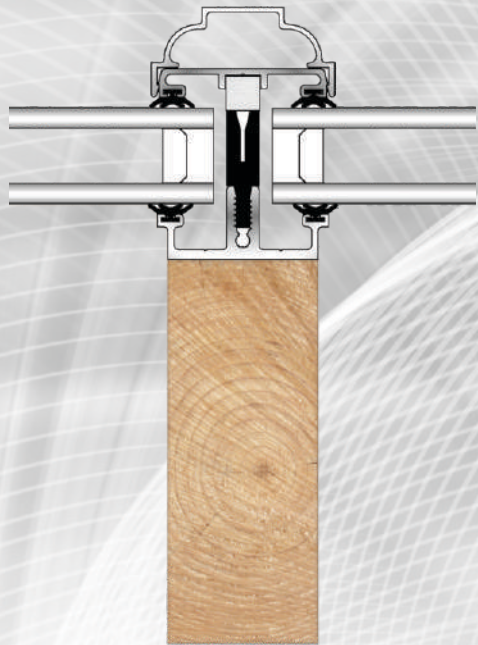

Rafterline SPG1 thermally broken aluminium glazing bar with PC1 screw-on capping and PC3 snap-on ornate cosmetic capping

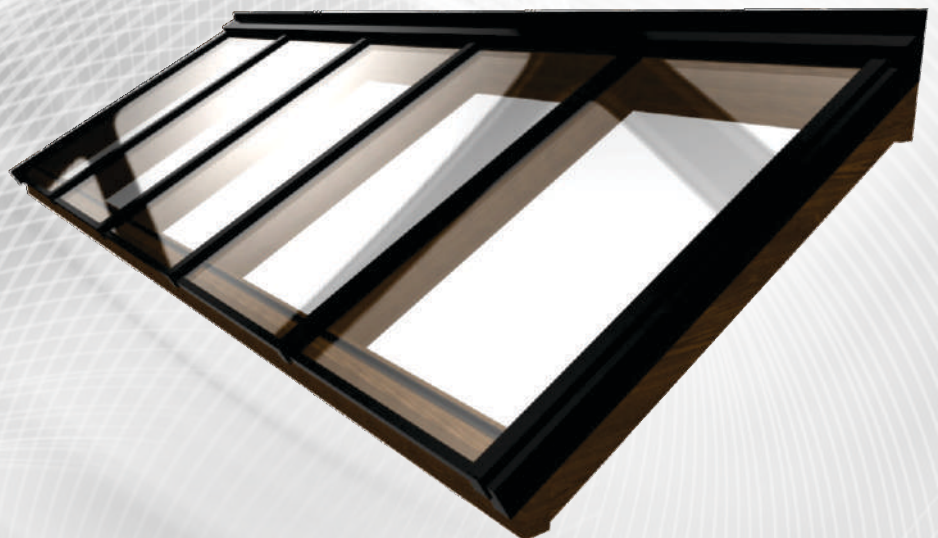
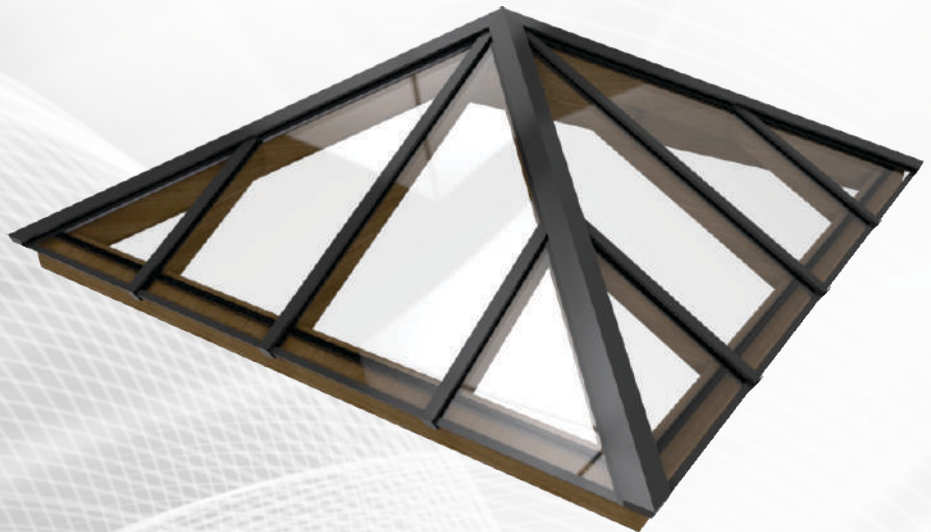
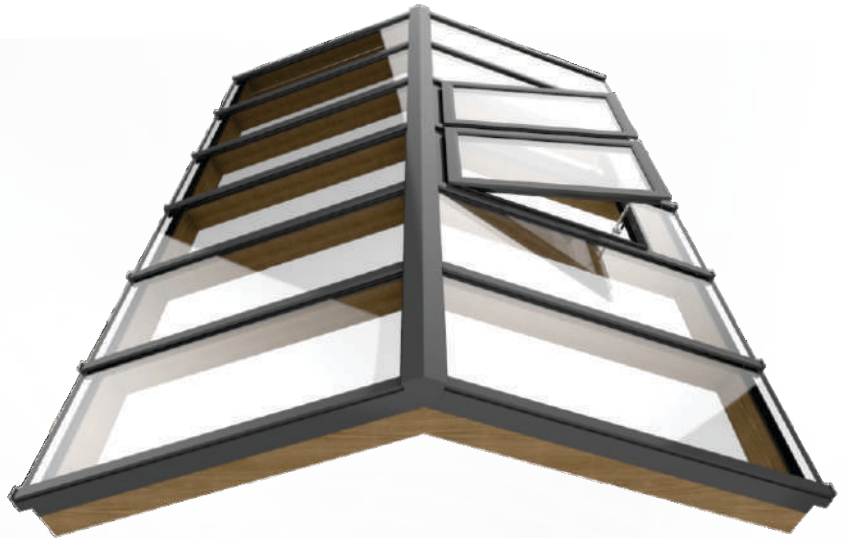



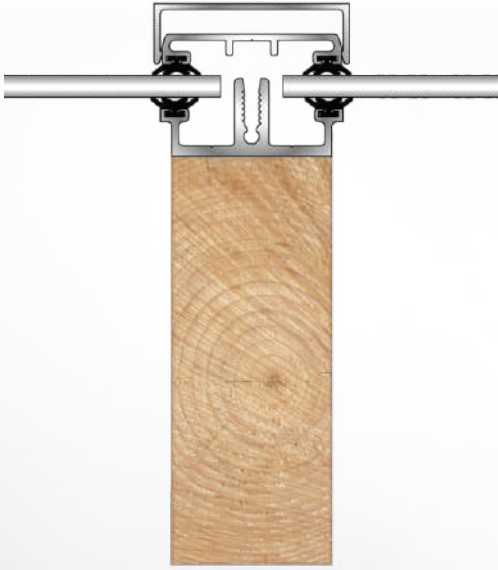

Rafterline SPG1 aluminium glazing bar with PC1 screw-on capping and PC2 snap-on square top cosmetic capping

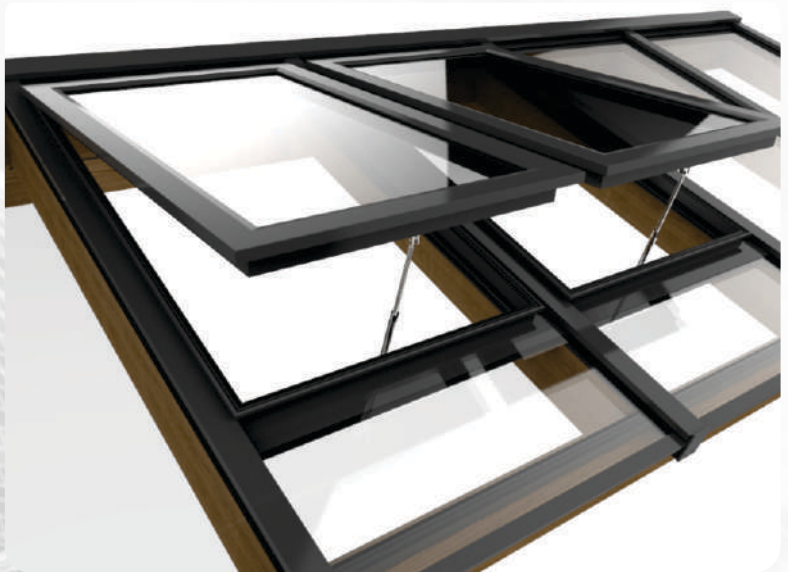
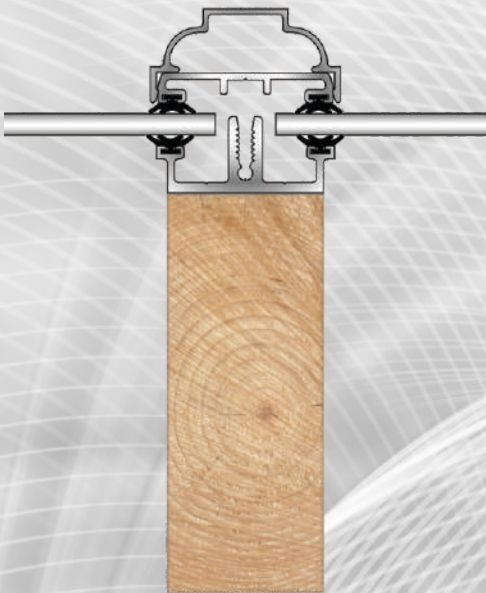

Rafterline SPG1 aluminium glazing bar with PC1 screw-on capping and PC3 snap-on ornate cosmetic capping



## **RAFTERLINE** SINGLE GLAZED

Domestic Property London



Architect - Nintim  
Photographer - Megan Taylor Photography

Domestic Property London

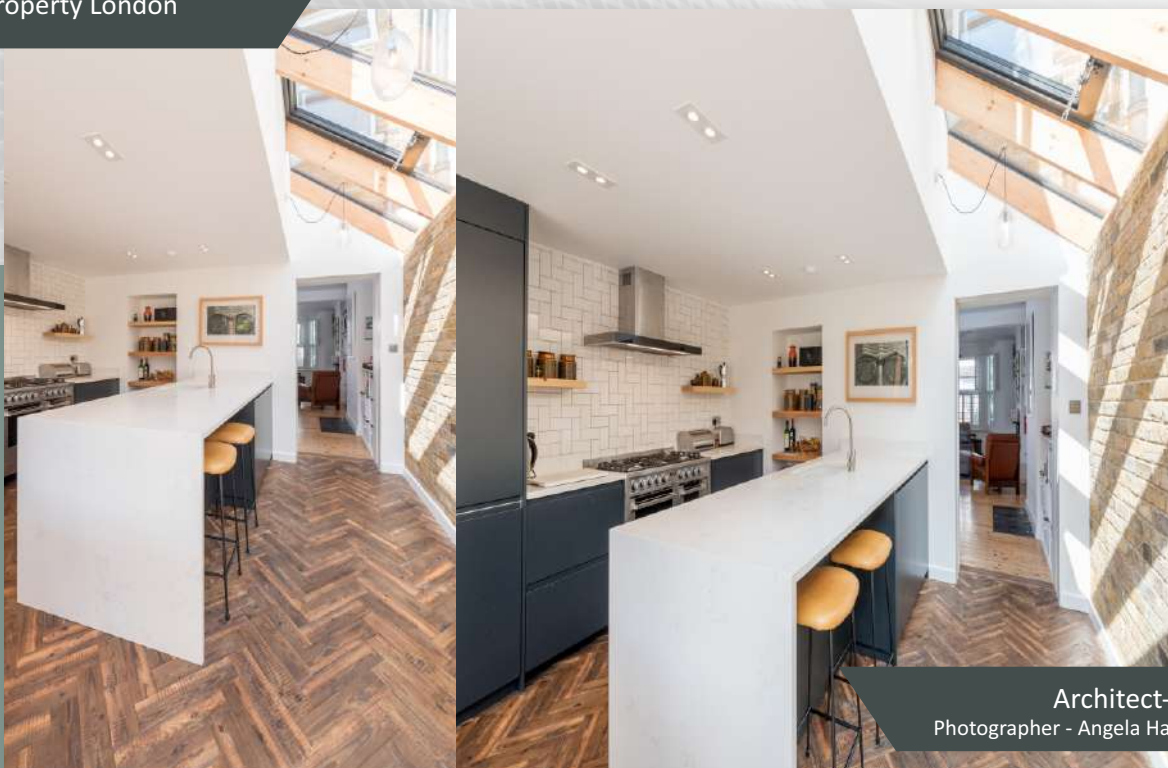

Architect-SS4 Architects  
Photographer - Angela Harding Photography





Ingestre Hall







HA Briddon Ltd



Syrencot House, Salisbury



Contractor: H Sweet & Sons Ltd





The Standard Patent Glazing Co Ltd  
Flagship House  
Forge Lane  
DEWSBURY  
West Yorkshire  
WF12 9EL

Tel 01924 461213

mail: [info@patent-glazing.com](mailto:info@patent-glazing.com)  
web: [www.patent-glazing.com](http://www.patent-glazing.com)

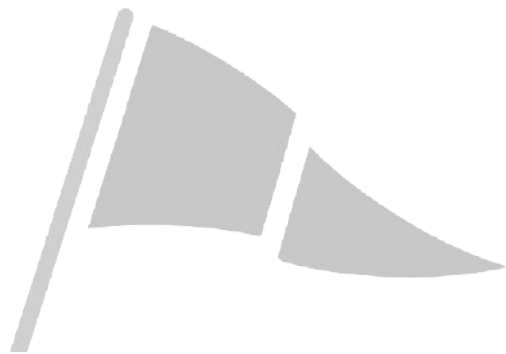

100 YEARS OF SERVICE